

Enphase IQ 6 and IQ 6+ Micros



Corporate Headquarters Contact Information

Enphase Energy Inc.
1420 N. McDowell Blvd.
Petaluma, CA 94954
USA

enphase.com/en-us/support/contact

FCC Compliance

This equipment has been tested and found to comply with the limits for a Class B digital device, pursuant to part 15 of the FCC Rules. These limits are designed to provide reasonable protection against harmful interference in a residential installation. This equipment generates, uses and can radiate radio frequency energy and, if not installed and used in accordance with the instructions, may cause harmful interference to radio communications. However, there is no guarantee that interference will not occur in a particular installation. If this equipment does cause harmful interference to radio or television reception, which can be determined by turning the equipment off and on, you are encouraged to try to correct the interference by one or more of the following measures:

- Reorient or relocate the receiving antenna.
- Increase the separation between the equipment and the receiver.
- Connect the equipment into an outlet on a circuit different from that to which the receiver is connected.
- Consult the dealer or an experienced radio/TV technician for help.

Changes or modifications not expressly approved by the party responsible for compliance may void the user's authority to operate the equipment.

Other Information

Product information is subject to change without notice. All trademarks are recognized as the property of their respective owners.

User documentation is updated frequently; Check the Enphase website (enphase.com/support) for the latest information.

To ensure optimal reliability and to meet warranty requirements, the Enphase Microinverter must be installed according to the instructions in this manual. For warranty text refer to enphase.com/warranty.

For Enphase patent information refer to enphase.com/company/patents/.

© 2018 Enphase Energy Inc. All rights reserved.

Audience

This manual is intended for use by professional installation and maintenance personnel.

Table of Contents

Important Safety Information	5
Read this First	5
Product Labels	5
Safety and Advisory Symbols.....	5
IQ 6 Microinverter Safety Instructions	5
PV Rapid Shutdown Equipment (PVRSE)	7
The Enphase IQ System.....	8
How the Enphase IQ 6 and IQ 6+ Micros Work	9
System Monitoring	9
Optimal Reliability	9
Ease of Design.....	9
Planning for Microinverter Installation.....	10
Compatibility.....	10
Grounding Considerations.....	10
Branch Circuit Capacity.....	11
Utility Service Requirements	11
Wire Lengths and Voltage Rise.....	11
Lightning and Surge Suppression	12
Parts and Tools Required	13
Enphase Equipment.....	13
Other Items	13
Enphase Microinverter Installation.....	14
Step 1: Position the Enphase Q Cable	15
Step 2: Position the Junction Box.....	15
Step 3: Mount the Microinverters	16
Step 4: Create an Installation Map	17
Step 5: Manage the Cabling.....	18
Step 6: Connect the Microinverters	18
Step 7: Terminate the Unused End of the Cable.....	19
Step 8: Complete Installation of Junction Box.....	20
Step 9: Connect the PV Modules	20
Step 10: Energize the System.....	21
Set Up and Activate Monitoring.....	21
Troubleshooting	22
Status LED Indications and Error Reporting	22
LED Operation	22
DC Resistance Low – Power Off Condition	22
Other Faults	23
Troubleshoot an Inoperable Microinverter.....	24
Disconnect a Microinverter.....	25
Install a Replacement Microinverter	26
Ordering Replacement Parts.....	28
Enphase Q Cable Planning and Ordering	28
Connector Spacing Options	28
Cabling Options.....	28
Enphase Q Cable Accessories.....	29
Technical Data.....	30
Technical Considerations	30
Grid Interconnection Details.....	31
Grid Profiles	31
Manufacturer’s Stated Accuracy	31
Volt VAr Characteristics	32

SA9: Low/High Voltage/Frequency Ride Through (L/HV/FRT) and Must Trip Settings	32
SA10: Low/High Frequency Ride Through (L/H FRT) and Must Trip Settings	33
SA11: Ramp Rate (RR) and Soft Start (SS)	33
SA12: Specified Power Factor (SPF), aka (INV3)	33
SA13: Volt/VAr Mode (VV)	33
SA14: Frequency-Watt (FW).....	34
SA15: Volt-Watt (VW)	34
Specifications	35
IQ6-60-2-US Microinverter Specifications.....	35
IQ6PLUS-72-2-US Microinverter Specifications	38
Q Cable Specifications.....	40
Enphase Connector Ratings	40
Enphase Installation Map	41
Sample Wiring Diagram:	42

Important Safety Information

Read this First

This manual contains important instructions for use during installation and maintenance of the IQ 6 Micro™ and the IQ 6+ Micro™.

IMPORTANT: Enphase IQ Series Microinverters require the Q Cable and are not compatible with previous Enphase cabling. An IQ Envoy is required to monitor performance of the IQ Microinverters. The Q Accessories work only with Enphase IQ Series Microinverters.

Product Labels

The following symbols appear on the **product label** and are described here:



WARNING: Hot surface.



DANGER: Refer to safety instructions.



DANGER: Risk of electrical shock.







Refer to manual



Double-insulated

Safety and Advisory Symbols



To reduce the risk of electric shock, and to ensure the safe installation and operation of the Enphase IQ System, the following safety symbols appear throughout this document to indicate dangerous conditions and important safety instructions.

	DANGER:	This indicates a hazardous situation, which if not avoided, will result in death or serious injury.
	WARNING:	This indicates a situation where failure to follow instructions may be a safety hazard or cause equipment malfunction. Use extreme caution and follow instructions carefully.
	WARNING:	This indicates a situation where failure to follow instructions may result in burn injury.
	NOTE:	This indicates information that is very important for optimal system operation. Follow instructions closely.







IQ 6 Microinverter Safety Instructions

General Safety











	DANGER: Risk of electric shock. Risk of fire.	Only use electrical system components approved for wet locations.
		Only qualified personnel should install, troubleshoot, or replace Enphase Microinverters or Enphase Q Cable and Accessories.
		Ensure that all AC and DC wiring is correct and that none of the AC or DC wires are pinched, shorted or damaged. Ensure that all AC junction boxes are properly closed.
		Do not exceed the maximum number of microinverters in an AC branch circuit as listed in the manual. You must protect each microinverter AC branch circuit with a 20 A maximum breaker or fuse as appropriate.

	DANGER: Risk of electric shock.	<p>Do not use Enphase equipment in a manner not specified by the manufacturer. Doing so may cause death or injury to persons, or damage to equipment.</p> <p>Be aware that installation of this equipment includes risk of electric shock.</p> <p>The DC conductors of this photovoltaic system are ungrounded and may be energized.</p> <p>Always de-energize the AC branch circuit before servicing. While connectors are rated for disconnect under load, Enphase does not recommend disconnecting the DC connectors under load.</p>
	WARNINGS:	<p>Before installing or using the Enphase Microinverter, read all instructions and cautionary markings in the technical description, on the Enphase equipment and on the photovoltaic (PV) equipment.</p> <p>Do not connect Enphase Microinverters to the grid or energize the AC circuit(s) until you have completed all of the installation procedures and have received approval from the electrical utility.</p> <p>When the PV array is exposed to light, DC voltage is supplied to the power conversion equipment (PCE).</p> <p>Risk of equipment damage. Enphase male and female connectors must only be mated with the matching male/female connector.</p>
	NOTES:	<p>To ensure optimal reliability and to meet warranty requirements, install the Enphase equipment according to the instructions in this manual.</p> <p>The AC and DC connectors on the cabling are rated as a disconnect only when used with an Enphase Microinverter.</p> <p>Protection against lightning and resulting voltage surge must be in accordance with local standards.</p> <p>Perform all electrical installations in accordance with all applicable local electrical codes, such as: the Canadian Electrical Code, Part 1; ANSI requirements; and NPFA 70 (NEC).</p>

Microinverter Safety

	WARNING: Risk of skin burn.	<p>The chassis of the Enphase Microinverter is the heat sink. Under normal operating conditions, the temperature could be 20° C above ambient, but under extreme conditions the microinverter can reach a temperature of 90° C. To reduce risk of burns, use caution when working with microinverters.</p>
	DANGER: Risk of fire.	<p>The DC conductors of the PV module must be labeled “PV Wire” or “PV Cable” when paired with the Enphase Microinverter.</p>
	DANGER: Risk of electric shock. Risk of fire.	<p>Only qualified personnel may connect the Enphase Microinverter to the utility grid.</p> <p>Do not attempt to repair the Enphase Microinverter; it contains no user-serviceable parts. If it fails, contact Enphase customer service to obtain a return merchandise authorization (RMA) number and start the replacement process. Tampering with or opening the Enphase Microinverter will void the warranty.</p>
	WARNING: Risk of equipment damage	<p>Install the microinverter under the PV module to avoid direct exposure to rain, UV, and other harmful weather events. Always install the microinverter bracket side up. Do not mount the microinverter upside down. Do not expose the AC or DC connectors (on the Enphase Q Cable, PV module, or the microinverter) to rain or condensation before the connectors are mated.</p> <p>The maximum open circuit voltage of the PV module must not exceed the specified maximum input DC voltage of the Enphase Microinverter.</p>
	WARNING: Risk of equipment damage	<p>You must match the DC operating voltage range of the PV module with the allowable input voltage range of the Enphase Microinverter.</p> <p>The Enphase Microinverter is not protected from damage due to moisture trapped in cabling systems. Never mate microinverters to cables that have been left disconnected and exposed to wet conditions. This voids the Enphase warranty.</p> <p>The Enphase Microinverter functions only with a standard, compatible PV module with appropriate fill-factor, voltage, and current ratings. Unsupported devices include smart PV modules, fuel cells, wind or water turbines, DC generators, and non-Enphase batteries, etc. These devices do not behave like standard PV modules, so operation and compliance is not guaranteed. These devices may also damage the Enphase Microinverter by exceeding its electrical rating, making the system potentially unsafe.</p>
	NOTES:	<p>The Enphase Microinverter has field-adjustable voltage and frequency trip points that may need to be set, depending upon local requirements. Only an authorized installer with the permission and following requirements of the local electrical authorities should make adjustments.</p>

Enphase Q Cable and Accessory Safety

	DANGER: Risk of electric shock.	Do not install the Enphase Q Cable terminator while power is connected.
	WARNING: Risk of electric shock. Risk of fire.	When stripping the sheath from the Q Cable, make sure the conductors are not damaged. If the exposed wires are damaged, the system may not function properly.
	WARNING:	Do not leave AC connectors on the Q Cable uncovered for an extended period. You must cover any unused connector with a sealing cap.
	WARNING:	Make sure protective sealing caps have been installed on all unused AC connectors. Unused AC connectors are live when the system is energized.
	WARNING:	Use the terminator only once. If you open the terminator following installation, the latching mechanism is destroyed. If the latching mechanism is defective, do not use the terminator. Do not circumvent or manipulate the latching mechanism.
	WARNING:	When installing the Enphase Q Cable, secure any loose cable to minimize tripping hazard.
	NOTES:	When looping the Enphase Q Cable, do not form loops smaller than 4.75" (12 cm) in diameter.
	NOTES:	Provide support for the Enphase Q-Cable every 1.8m (6 feet).
	NOTES:	If you need to remove a sealing cap, you must use the Enphase disconnect tool.
	NOTES:	<p>When installing the Enphase Q Cable and accessories, adhere to the following:</p> <ul style="list-style-type: none"> • Do not expose the terminator cap or cable connections to directed, pressurized liquid (water jets, etc.). • Do not expose the terminator or cable to continuous immersion. • Do not expose the terminator cap or cable connections to continuous tension (e.g., tension due to pulling or bending the cable near the connection). • Use only the connectors provided. • Do not allow contamination or debris in the connectors. • Use the terminator cap and cable connections only when all parts are present and intact. • Do not install or use in potentially explosive environments. • Do not allow the terminator to come into contact with open flame. • Fit the terminator cap using only the prescribed tools and in the prescribed manner. • Use the terminator to seal the conductor end of the Enphase Q Cable; no other method is allowed.

PV Rapid Shutdown Equipment (PVRSE)

This product is UL Listed as PV Rapid Shut Down Equipment and conforms with NEC-2014 and NEC-2017 section 690.12 and C22.1-2015 Rule 64-218 Rapid Shutdown of PV Systems, for AC and DC conductors, when installed according to the following requirements:

- Microinverters and all DC connections must be installed inside the array boundary. Enphase further requires that the microinverters and DC connections be installed under the PV module to avoid direct exposure to rain, UV, and other harmful weather events.
- The array boundary is defined as 305 mm (1 ft.) from the array in all directions, or 1 m (3 ft.) from the point of entry inside a building.

This rapid shutdown system must be provided with an initiating device and (or with) status indicator which must be installed in a location accessible to first responders, or be connected to an automatic system which initiates rapid shutdown upon the activation of a system disconnect or activation of another type of emergency system.

The initiator shall be listed and identified as a disconnecting means that plainly indicates whether it is in the "off" or "on" position.

Examples are:

- Service disconnecting means
- PV system disconnecting means
- Readily accessible switch or circuit breaker

The handle position of a switch or circuit breaker is suitable for use as an indicator. Refer to NEC or CSA C22.1-2015 for more information.

Additionally, in a prominent location near the initiator device, a placard or label must be provided with a permanent marking including the following wording:

'PHOTOVOLTAIC SYSTEM EQUIPPED WITH RAPID SHUTDOWN' The term 'PHOTOVOLTAIC' may be replaced with 'PV.'

The placard, label, or directory shall be reflective, with all letters capitalized and having a minimum height of 9.5 mm (3/8") in white on red background.

The Enphase IQ System

The Enphase IQ System includes:

- **Enphase IQ 6 and/or IQ 6+ Micros** The smart grid ready IQ6 and IQ6+ Micros convert the DC output of the PV module into grid-compliant AC power.
- **Enphase IQ Envoy™** (ENV-IQ-AM1-240) The Enphase IQ Envoy is a communication device that provides network access to the PV array. The IQ Envoy collects production and performance data from the Enphase IQ Microinverters over on-site AC power lines and transmits the data to Enlighten through an Internet or cellular modem connection. The IQ Envoy is capable of monitoring up to 600 Enphase IQ Microinverters and up to 39 Enphase IQ Batteries. For details, refer to *Enphase IQ Envoy Installation and Operations Manual*.
- **Enphase Enlighten™** web-based monitoring and management software. Installers can use Enlighten Manager to view detailed performance data, manage multiple PV systems, and remotely resolve issues that might impact system performance. Find out more at enphase.com/enlighten.
- **Enphase Installer Toolkit™** mobile app for iOS and Android devices. It allows installers to configure the system while onsite, eliminating the need for a laptop and improving installation efficiency. You can use the app to:
 - Connect to the IQ Envoy over a wireless network for faster system setup and verification
 - View and email a summary report that confirms a successful installation
 - Scan device serial numbers and sync system information with Enlighten monitoring software
- **Enphase IQ Battery™** (IQ6PLUS-B1200-LL-I-US00-RV1)
- **Enphase Field Wireable connectors** (Q-CONN-10F and Q-CONN-10M) **Make** connections from any Q Cable, or open Field Wireable connector.

This manual details the safe installation and operation of the Enphase Microinverter.



NOTE: To ensure optimal reliability and to meet warranty requirements, the Enphase Microinverter must be installed according to the instructions in this manual.

How the Enphase IQ 6 and IQ 6+ Micros Work

The Enphase Microinverter maximizes energy production by using a sophisticated Maximum Power Point Tracking (MPPT) algorithm. Each Enphase Microinverter individually connects to one PV module in your array. This configuration enables an individual MPPT to control each PV module, ensuring that maximum power available from each PV module is exported to the utility grid regardless of the performance of the other PV modules in the array. While an individual PV module in the array may be affected by shading, soiling, orientation, or PV module mismatch, each Enphase Microinverter ensures top performance for its associated PV module.

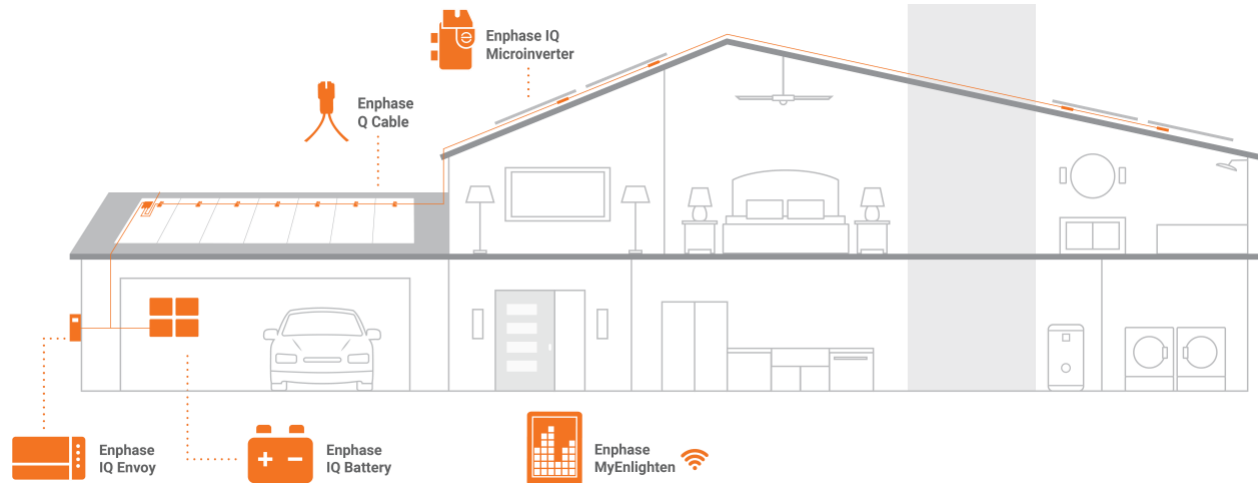

System Monitoring

Once you install the Enphase IQ Envoy and provide an internet connection through a broadband router or modem, the Enphase IQ Microinverters automatically begin reporting to Enlighten. Enlighten presents current and historical system performance trends, and informs you of PV system status.

Optimal Reliability

Microinverter systems are inherently more reliable than traditional inverters. The distributed nature of a microinverter system ensures that there is no single point of system failure in the PV system. Enphase Microinverters are designed to operate at full power at ambient temperatures as high as 65° C (150° F).

Ease of Design

PV systems using Enphase Microinverters are very simple to design and install. You will not need string calculations or cumbersome traditional inverters. You can install individual PV modules in any combination of PV module quantity, type, age and orientation. Each microinverter quickly mounts on the PV racking, directly beneath each PV module. Low voltage DC wires connect from the PV module directly to the co-located microinverter, eliminating the risk of personnel exposure to dangerously high DC voltage.

Planning for Microinverter Installation

The Enphase IQ 6 Micro is compatible with 60-cell PV modules, and the IQ 6+ Micro supports PV modules with 60 or 72 Cells. Both install quickly and easily. The microinverter housing is designed for outdoor installation and complies with the NEMA 250, type 6 environmental enclosure rating standard:



NEMA 6 rating definition: Indoor or outdoor use primarily to provide a degree of protection against hose-directed water, the entry of water during occasional temporary submersion at a limited depth, and damage from external ice formation

The Enphase Q Cable is available in multiple connector spacing options for landscape and portrait orientations in 60 and 72-cell PV modules to meet varying site requirements. For Enphase Q Cable ordering information, see “Enphase Q Cable Planning and Ordering” on page 28.

Compatibility

The Enphase IQ 6 and IQ 6+ Micros are **electrically compatible** with PV modules as listed in the following table. For specifications, see “Technical Data” on page 30 of this manual. You can refer to the Enphase Compatibility Calculator at: enphase.com/en-us/support/module-compatibility to verify PV module electrical compatibility. To ensure **mechanical compatibility**, be sure to order the correct connector type for both microinverter and PV module from your distributor.



WARNING: Risk of fire. The PV module DC conductors must be labeled "PV Wire" or "PV Cable" to comply with NEC for Ungrounded PV Power Systems.

Microinverter model	Connector type	PV module cell count
IQ6-60-2-US	MC-4 locking type	Pair only with 60-cell modules.
IQ6PLUS-72-2-US	MC-4 locking type	Pair with 60 or 72-cell modules

Grounding Considerations

The Enphase Microinverter models listed in this guide do not require grounding electrode conductors (GEC), equipment grounding conductors (EGC), or grounded conductor (neutral). Your Authority Having Jurisdiction (AHJ) may require you to bond the mounting bracket to the racking. If so, use UL2703 hardware or star washers. The microinverter itself has a Class II double-insulated rating, which includes ground fault protection (GFP). To support GFP, use only PV modules equipped with DC cables labeled PV Wire or PV Cable.

Branch Circuit Capacity

Plan your AC branch circuits to meet the following limits for maximum number of microinverters per branch when protected with a 20 amp (maximum) over current protection device (OCPD).

Maximum IQ 6 Micros per AC branch circuit (240 VAC)	Maximum IQ 6+ Micros per AC branch circuit (240 VAC)
16	13
Maximum IQ 6 Micros per AC branch circuit (208 VAC)	Maximum IQ 6+ Micros per AC branch circuit (208 VAC)
14	11

Utility Service Requirements

The Enphase IQ 6 and IQ 6+ work with single-phase service. Measure AC line voltages at the electrical utility connection to confirm that it is within the ranges shown:

240 Volt AC, Single Phase	
L1 to L2	211 to 264 VAC
L1, L2 to ground	106 to 132 VAC
208 Volt AC, Single Phase	
L1 to L2	183 to 229 VAC
L1, L2 to ground	106 to 132 VAC

Wire Lengths and Voltage Rise

When planning the system, you must select the appropriate AC conductor size to minimize voltage rise. Select the correct wire size based on the distance from the beginning of the microinverter AC branch circuit to the breaker in the load center. Enphase recommends a voltage rise total of less than 2% for the sections from the microinverter AC branch circuit to the breaker in the load center.

Enphase provides guidance about choosing wire size and maximum conductor lengths in the Voltage Rise Technical Brief at enphase.com/support. Refer to this brief for voltage rise values in Enphase Q Cables and on how to calculate voltage rise in other wire sections of the system.

Standard guidelines for voltage rise on feeder and AC branch circuit conductors might not be sufficient for microinverter AC branch circuits that contain the maximum allowable microinverters. This is due to high inherent voltage rise on the AC branch circuit.



Best practice: Center-feed the branch circuit to minimize voltage rise in a fully-populated branch. This practice greatly reduces the voltage rise as compared with an end-fed branch. To center-feed a branch, divide the circuit into two sub-branch circuits protected by a single OCPD.

Lightning and Surge Suppression

Enphase Microinverters have integral surge protection, greater than most traditional inverters. However, if the surge has sufficient energy, the protection built into the microinverter can be exceeded, and the equipment can be damaged. For this reason, Enphase recommends that you protect your system with a lightning and/or surge suppression device. In addition to having some level of surge suppression, it is also important to have insurance that protects against lightning and electrical surges. Enphase has tested the devices in the following tables.

Residential	Commercial
<ul style="list-style-type: none"> • Citel DS72-RS-120 surge protector; data sheet • Delta LA-302 lightning arrestor; website • Midnite solar surge protection device MNSPD-300 or MNSPD-300FM (with flush mount box); website 	<ul style="list-style-type: none"> • Citel DS73-RS-G surge protector; data sheet • Delta LA-303 lightning arrestor; website



NOTE: Protection against lightning and resulting voltage surge must be in accordance with local standards.

Parts and Tools Required

In addition to the microinverters, PV modules, and racking, you will need the following:

Enphase Equipment

- Enphase IQ Envoy communications gateway (ENV-IQ-AM1-240) required to monitor solar production. For installation information, refer to the ***Enphase IQ Envoy Installation and Operations Manual***.
- Enphase Installer Toolkit
Download the Enphase Installer Toolkit mobile app and open it to log in to your Enlighten account. With this app, you can scan microinverter serial numbers and connect to the IQ Envoy to track system installation progress. To download, go to enphase.com/toolkit or scan the QR code at right.
- Tie wraps or Q Cable Clips (Q-CLIP-100)
- Enphase Sealing caps (Q-SEAL-10) for any unused drops on the Enphase Q Cable
- Enphase Terminator (Q-TERM-10) typically two needed per branch circuit
- Enphase Disconnect Tool (Q-DISC-10)
- Field Wireable Connectors (male and female: Q-CONN-10M and Q-CONN-10F)
- Enphase Q Cable:



Cable Model	Connector Spacing	PV Module Orientation	Connector Count per box
Q-12-10-240	1.3m	Portrait	240
Q-12-17-240	2.0m	Landscape (60-cell)	240
Q-12-20-200	2.3m	Landscape (72-cell)	200

Other Items

- Number 2 and 3 screwdrivers
- Wire cutters, voltmeter
- Torque wrench, sockets, wrenches for mounting hardware

Enphase Microinverter Installation

Installing the Enphase IQ 6 and IQ 6+ Micros involves several key steps. Each step listed here is detailed in the following pages.

- Step 1:** Position the Enphase Q Cable
- Step 2:** Position the Junction Box
- Step 3:** Mount the Microinverters
- Step 4:** Create an Installation Map
- Step 5:** Manage the Cabling
- Step 6:** Connect the Microinverters
- Step 7:** Terminate the Unused End of the Cable
- Step 8:** Complete Installation of Junction Box
- Step 9:** Connect the PV Modules
- Step 10:** Energize the System

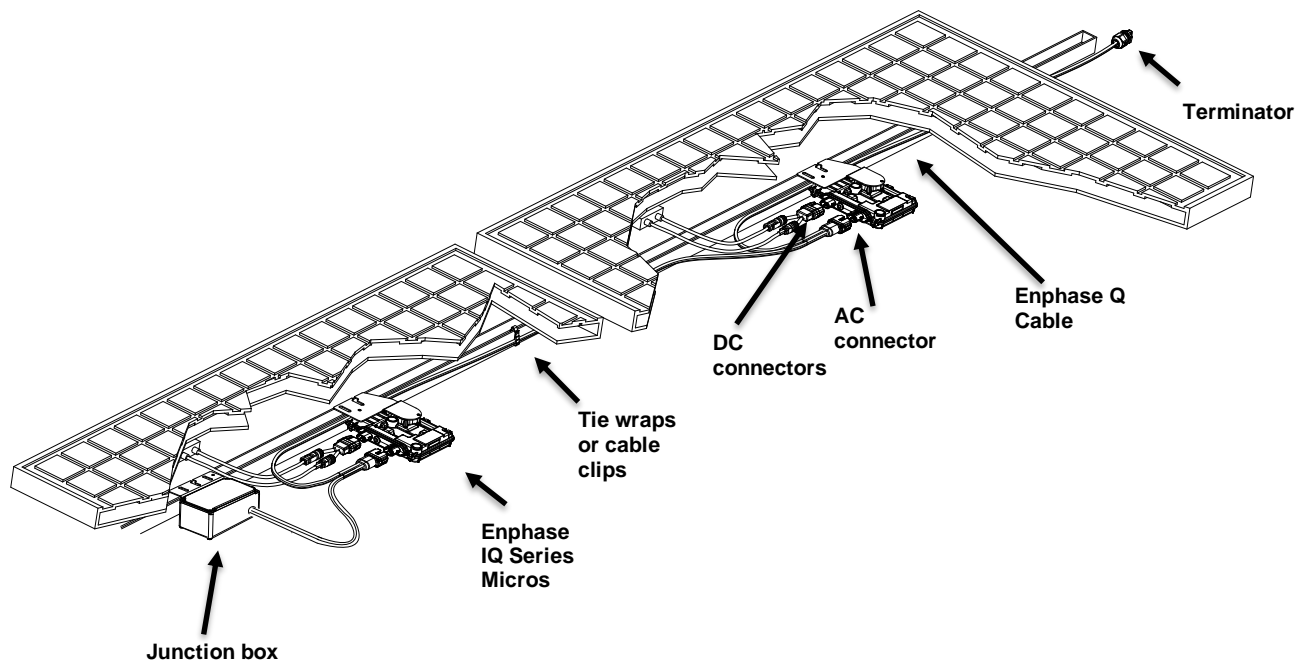

Step 1: Position the Enphase Q Cable

- A. Plan each cable segment to allow drop connectors on the Enphase Q Cable to align with each PV module. Allow extra length for slack, cable turns, and any obstructions.
- B. Mark the approximate centers of each PV module on the PV racking.
- C. Lay out the cabling along the installed racking for the AC branch circuit.
- D. Cut each segment of cable to meet your planned needs.



WARNING: When transitioning between rows, secure the cable to the rail to prevent cable damage or connector damage. Do not count on connector to withstand tension.

Step 2: Position the Junction Box

- A. Verify that AC voltage at the site is within range.

Service Type and Voltage: L1-L2	
240 V Split-Phase	211 to 264 VAC
208 V Single-Phase	183 to 229 VAC

- B. Install a junction box at a suitable location on the racking.

Step 3: Mount the Microinverters

- A. If the Enphase DC bulkhead connectors are not already attached to the microinverters, attach them now. Make sure they are fully seated.
- B. **Mount the microinverter bracket side up (as shown) and under the PV module, away from rain and sun.** Allow a minimum of 1.9 cm (3/4") between the roof and the microinverter. Also allow 1.3 cm (1/2") between the back of the PV module and the top of the microinverter.



WARNING: Install the microinverter under the PV module to avoid direct exposure to rain, UV and other harmful weather events. Do not mount the microinverter upside down.

- C. Torque the microinverter fasteners as follows. **Do not over torque.**
 - 6 mm (1/4") mounting hardware: 5 N m (45 to 50 in-lbs.)
 - 8 mm (5/16") mounting hardware: 9 N m (80 to 85 in-lbs.)
 - When using UL 2703 mounting hardware, use the manufacturer's recommended torque value

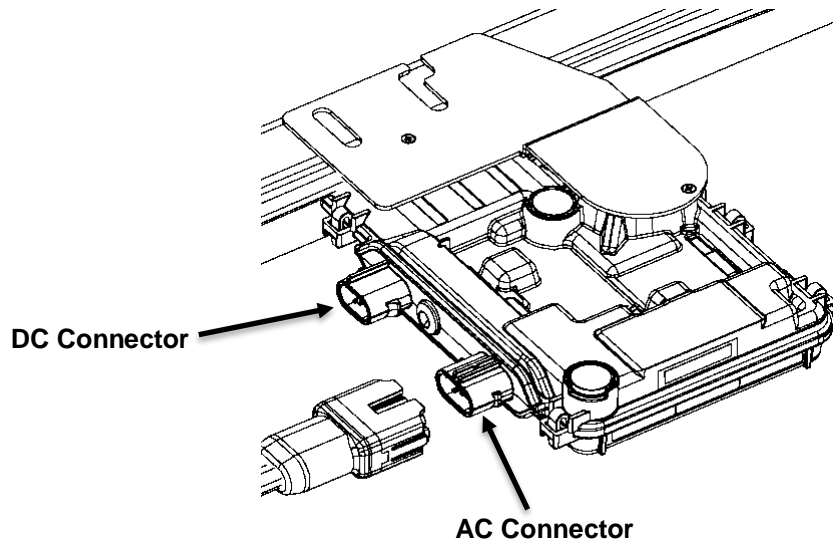

Step 4: Create an Installation Map

The Enphase Installation Map is a diagram of the physical location of each microinverter in your PV installation. Copy or use the blank map on page 40 to record microinverter placement for the system, or provide your own layout if you require a larger or more intricate installation map.

Each Enphase Microinverter, Envoy, and Battery have a removable serial number label. Build the installation map by peeling the serial number labels from the microinverter mounting plates and placing the labels on the map. You will also place the Enphase IQ Envoy and IQ Battery serial number on the map after installation.

After you have created the installation map, use the Enphase Installer Toolkit mobile app to record serial numbers and configure the system.

For Installer Toolkit details refer to “Detect the Microinverters” in the help topics of the Installer Toolkit app.

- A. Peel the removable serial number label from each microinverter and affix it to the respective location on the paper installation map.
- B. Peel the label from the IQ Envoy and any Enphase Battery, if installed) and affix it to the installation map.
- C. Always keep a copy of the installation map for your records.

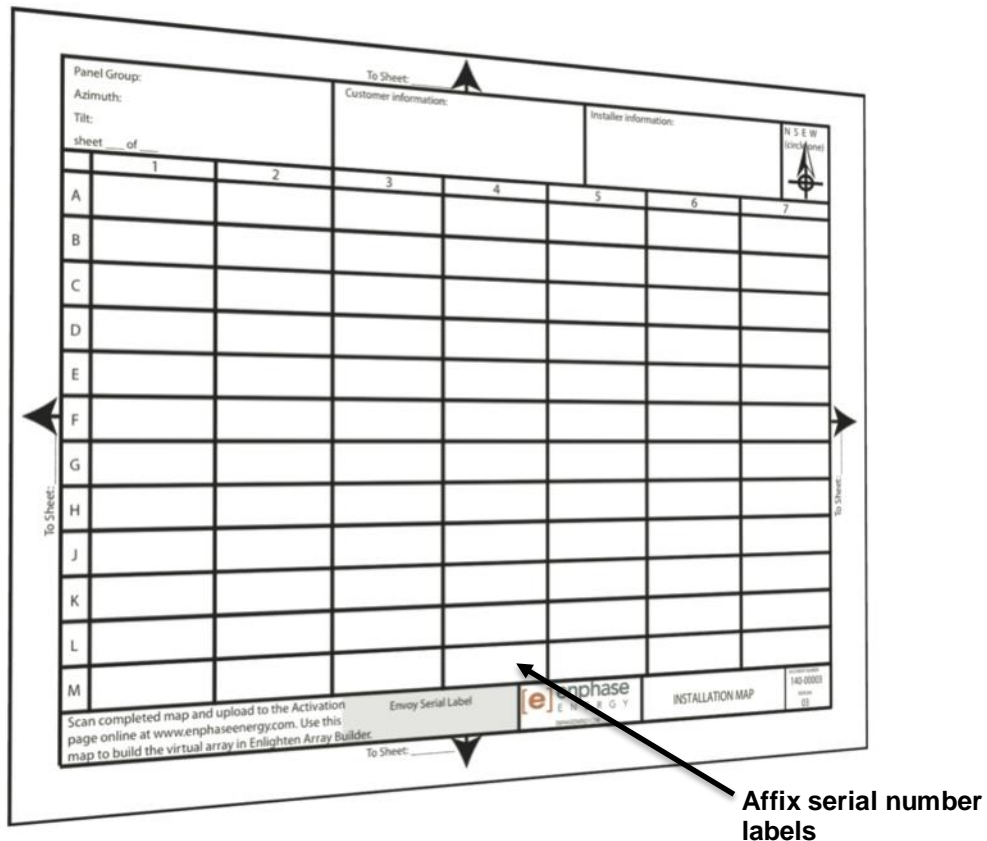

Step 5: Manage the Cabling

- A. Use cable clips or tie wraps to attach the cable to the racking. Leave no more than 1.8 m (six feet) between cable clips or tie wraps.

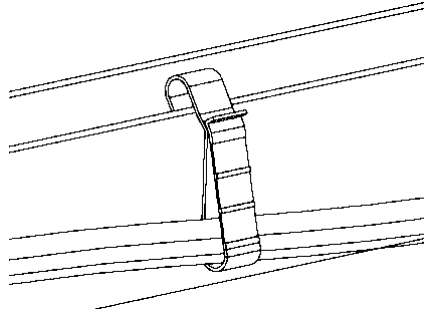

Cable clip

- B. Dress any excess cabling in loops so that it does not contact the roof. Do not form loops smaller than 12 cm (4¾") in diameter.



WARNING: Tripping Hazard. Loose cables can become a tripping hazard. Dress the Enphase Q Cable to minimize this potential.

Step 6: Connect the Microinverters

- A. Connect the microinverter. Listen for a click as the connectors engage.
- B. Cover any unused connector with Enphase Sealing Caps. Listen for a click as the connectors engage.

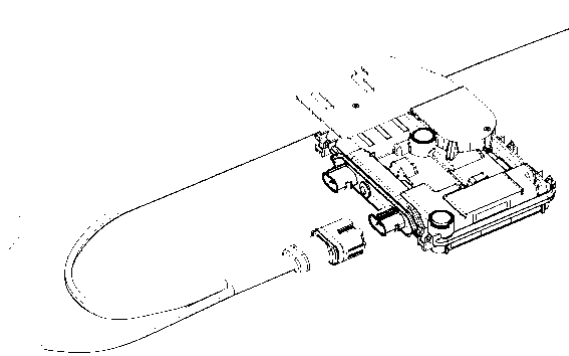

WARNING: Risk of electric shock. Risk of fire. Install sealing caps on all unused AC connectors as these connectors become live when the system is energized. Sealing caps are required for protection against moisture ingress.



NOTE: If you need to remove a sealing cap, you must use the Enphase Disconnect Tool. See "Disconnect a Microinverter" on page 25.

Step 7: Terminate the Unused End of the Cable

Terminate the unused end of the Enphase Q Cable as follows.

- Remove 13 mm ($\frac{1}{2}$ inch) of the cable sheath from the conductors. Use the terminator loop to measure 13 mm.
- Slide the hex nut onto the cable. There is a grommet inside of the hex nut that should remain in place.
- Insert the cable into the terminator body so that each of the two wires land on opposite sides of the internal separator.

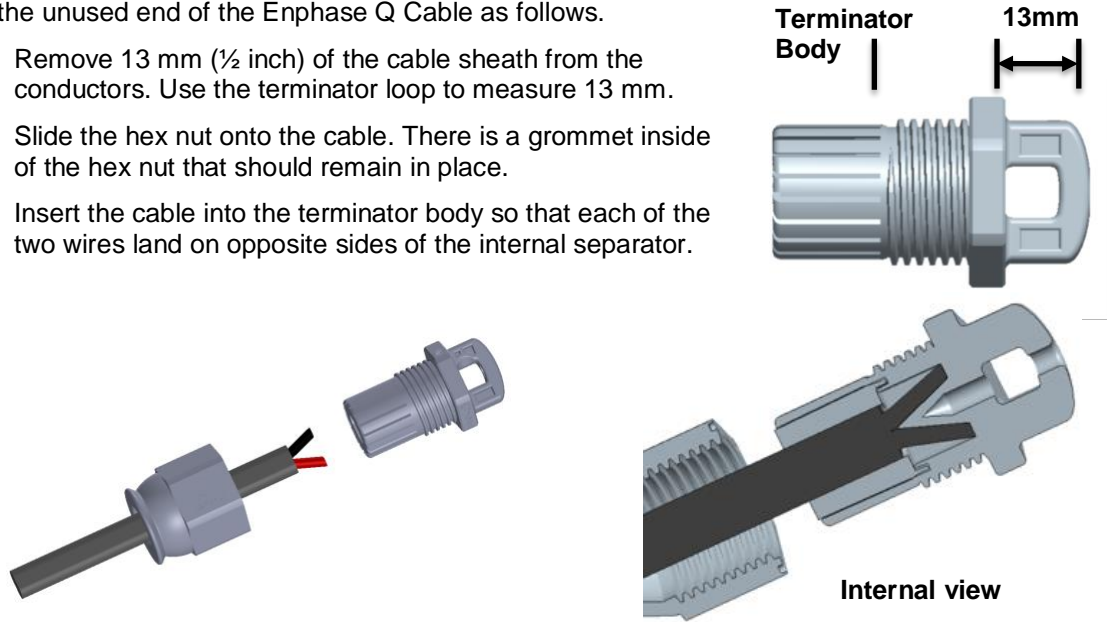

- Insert a screwdriver into the slot on top of the terminator to hold it in place, and use a torque wrench or channel lock pliers to tighten the hex nut until the threads disappear. Torque to 7 Nm.
- Hold the terminator body stationary with the screwdriver and turn only the hex nut to prevent the conductors from twisting out of the separator.



NOTE: Hold the terminator body stationary with the screw driver and turn only the hex nut to prevent conductors from twisting out of the separator.

- Attach the terminated cable end to the PV racking with a cable clip or tie wrap so that the cable and terminator do not touch the roof.



WARNING: Never unscrew the hex nut. Unscrewing the hex nut destroys the locking feature, and you must replace the terminator.



Step 8: Complete Installation of Junction Box

- A. Connect the Enphase Q Cable into the junction box.
- B. Refer to the wiring diagrams on page 42 for more information. Wire colors are listed in the following table.

Wire Colors
L1 – Black
L2 – Red

Step 9: Connect the PV Modules



WARNING: Electrical shock hazard. The DC conductors of this photovoltaic system are ungrounded and may be energized.

- A. Connect the DC leads of each PV module to the DC input connectors of the corresponding microinverter.

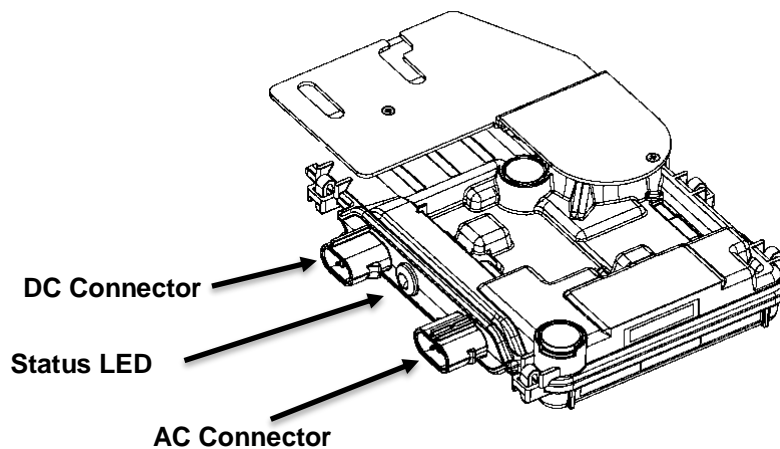

- B. Check the LED on the connector side of the microinverter. The LED flashes six times when DC power is applied.
- C. Mount the PV modules above the microinverters.

Step 10: Energize the System

- A. If applicable, turn ON the AC disconnect or circuit breaker for the branch circuit.
- B. Turn ON the main utility-grid AC circuit breaker. Your system starts producing power **after a five-minute wait time.**
- C. Check the LED on the connector side of the microinverter:

LED color	Indicates
Flashing green	Normal operation. AC grid function is normal there is communication with the IQ Envoy.
Flashing orange	The AC grid is normal but there is no communication with the IQ Envoy.
Flashing Red	The AC grid is either not present or not within specification.
Solid Red	There is an active "DC Resistance Low, Power Off Condition." To reset, see "DC Resistance Low – Power Off Condition" on page 22.

Set Up and Activate Monitoring

Refer to the *Enphase IQ Envoy Quick Install Guide* to install the IQ Envoy and set up system monitoring and grid management functions. This guide leads you through the following:

- Connecting the Envoy
- Detect devices
- Connecting to Enlighten
- Registering the system
- Building the virtual array



NOTE: When the utility requires a profile other than the default IEEE 1547 (for example grids managed by Hawaii Electric Industries [HEI] including HECO) you must select an appropriate grid profile for your installation. You can set the grid profile through Enlighten, during system registration, or through Installer Toolkit at any time. You must have an Enphase Envoy communications gateway to set or change the grid profile. For more information on setting or changing the grid profile, refer to the *Enphase IQ Envoy Installation and Operation Manual* at enphase.com/support.

Troubleshooting

Follow all the safety measures described throughout this manual. Qualified personnel can use the following troubleshooting steps if the PV system does not operate correctly.



WARNING: Risk of electric shock. Do not attempt to repair the Enphase Microinverter; it contains no user-serviceable parts. If it fails, contact Enphase customer service to obtain an RMA (return merchandise authorization) number and start the replacement process.

Status LED Indications and Error Reporting

The following section describes LED indications.

LED Operation

LED color	Indicates
Flashing green	Normal operation. AC grid function is normal there is communication with the Envoy.
Flashing orange	The AC grid is normal but there is no communication with the Envoy.
Flashing red	The AC grid is either not present or not within specification.
Solid red	There is an active “DC Resistance Low, Power Off Condition.” To reset, see “DC Resistance Low – Power Off Condition” on page 22.

The status LED on each microinverter lights green about six seconds after DC power is applied. It remains lit solid for two minutes, followed by six green blinks. After that, red blinks indicate that no grid is present if the system is not yet energized.

Any short red blinks after DC power is first applied to the microinverter indicate a failure during microinverter startup.

DC Resistance Low – Power Off Condition

For all **IQ 6 and IQ 6+ models**, a solid red status LED when DC power has been cycled indicates the microinverter has detected a DC Resistance Low – Power Off event. The LED will remain red and the fault will continue to be reported by the Envoy until the error has been cleared.

An insulation resistance (IR) sensor in the microinverter measures the resistance between the positive and negative PV inputs to ground. If either resistance drops below a threshold, the microinverter stops power production and raises this condition. This may indicate defective module insulation, defective wiring or connectors, moisture ingress, or a similar problem. Although the cause may be temporary, this microinverter condition persists until the sensor is manually reset.

An IQ Envoy is required to clear this condition. The condition clears on operator command unless its cause is still present.

If a microinverter registers a “DC Resistance Low - Power Off” condition, you can attempt to clear this condition. If the condition does not clear after you perform the following procedure, contact Enphase Energy customer support at enphase.com/en-us/support/contact.



There are two ways to send a clear message to the microinverter. Note that the condition will not clear after sensor reset if the cause of the failure is still present. If the condition persists, contact your installer or Enphase Energy customer support at enphase.com/en-us/support/contact.

Method 1: Clear this Error Using Enlighten

- Log in to Enlighten and access the system.
- Click the **Events** tab. The next screen shows a current “DC Resistance Low - Power Off” condition for the system.
- Click **DC Resistance Low - Power Off**.
- Where “n” is the number of affected devices, click **n devices (show details)**.
- Click the serial number of the affected microinverter.
- Click **Reset DC Resistance Low - Power Off Sensor**.
The system displays, “A DC Resistance Low- Power Off reset task was issued on [date and time] for this microinverter and is still pending.”

Method 2: Use Installer Toolkit to Clear the Condition

On the list of detected microinverters, a green dot or red square appears to the left of each microinverter serial number. A green dot indicates Status OK. A red square indicates an event for that microinverter.

- Tap the  to the left of the serial number to view details for a microinverter event.
- If the microinverter status shows that there is an active **DC Resistance Low – Power Off** condition, tap the  to send the clear message to the affected microinverter. The app then indicates that a clear message was sent.

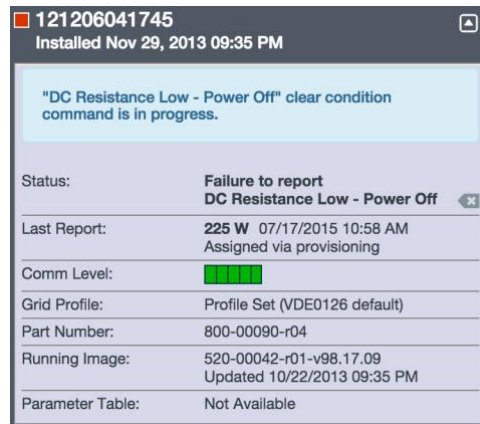
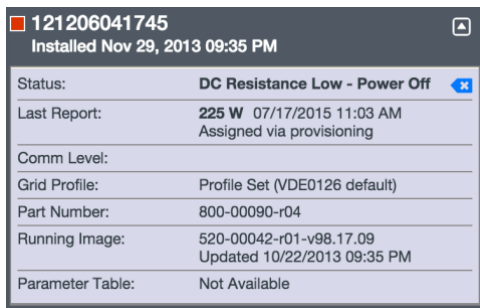

Other Faults

All other faults are reported to the Envoy. Refer to the *Enphase IQ Envoy Installation and Operation Manual* at enphase.com/support for troubleshooting procedures.

Troubleshoot an Inoperable Microinverter

To troubleshoot an inoperable microinverter, follow the steps in the order shown.



WARNING: Risk of electric shock. Always de-energize the AC branch circuit before servicing. Never disconnect the DC connectors under load.



WARNING: The Enphase Microinverters are powered by DC power from the PV modules. Make sure you disconnect the DC connections and reconnect DC power and then watch for the solid green about six seconds after connection to DC power.

- A. Make sure AC breakers and disconnects are closed.
- B. Check the connection to the utility grid and verify that the utility voltage is within allowable ranges.
- C. Verify that AC line voltages at all solar power circuit breakers at the load center and subpanels are within the ranges shown in the following table.
- D. Verify that AC line voltage at the junction box for each AC branch circuit is within the ranges shown in the following table:

240 Volt AC, Single Phase	
L1 to L2	211 to 264 VAC
L1, L2 to ground	106 to 132 VAC
208 Volt AC, Single Phase	
L1 to L2	183 to 229 VAC
L1, L2 to ground	106 to 132 VAC

- E. Using an Enphase disconnect tool, disconnect the AC cable for the microinverter in question from the Enphase Q Cable.
- F. Verify that utility power is present at the microinverter by measuring line to line and line to ground at the Enphase Q Cable connector.
- G. Visually check that the AC branch circuit connections (Enphase Q Cable and AC connections) are properly seated. Reseat if necessary. Check also for damage, such as rodent damage.
- H. Make sure that any upstream AC disconnects, as well as the dedicated circuit breakers for each AC branch circuit, are functioning properly and are closed.
- I. Disconnect and re-connect the DC PV module connectors. The status LED of each microinverter will light solid green a few seconds after connection to DC power and then blink green six times to indicate normal start-up operation about two minutes after connecting to DC power. The LED subsequently resumes normal operation if the grid is present. See page 22 for normal LED operation.
- J. Attach an ammeter clamp to one conductor of the DC cables from the PV module to measure microinverter current. This will be under one amp if AC is disconnected.

Verify the PV module DC voltage is within the allowable range shown in “

- K. Specifications” on page 35 of this manual.

- L. Swap DC leads with a known good, adjacent PV module. If after checking Enlighten periodically (this may take up to 30 minutes), the problem moves to the adjacent module, this indicates that the PV module isn't functioning correctly. If it stays in place, the problem is with the original microinverter. Contact [Enphase Customer Support](#) for help in reading the microinverter data and for help in obtaining a replacement microinverter, if needed.
- M. Check the DC connections between the microinverter and the PV module. The connection may need to be tightened or reseated. If the connection is worn or damaged, it may need replacement.
- N. Verify with your utility that line frequency is within range.
- O. If the problem persists, contact Customer Support at enphase.com/en-us/support/contact.

Disconnect a Microinverter

If problems remain after following the troubleshooting steps listed previously, contact Enphase at enphase.com/en-us/support/contact. If Enphase authorizes a replacement, follow the steps below. To ensure the microinverter is not disconnected from the PV modules under load, follow the disconnection steps in the order shown:

- A. De-energize the AC branch circuit breaker.
- B. Enphase AC connectors are tool-removable only. To disconnect the microinverter from the Enphase Q Cable, insert the disconnect tool and remove the connector.
- C. Cover the PV module with an opaque cover.
- D. Using a clamp-on meter, verify there is no current flowing in the DC wires between the PV module and the microinverter. If current is still flowing, check that you have completed steps one and two above.



NOTE: Take care when measuring DC current as most clamp-on meters must be zeroed first and tend to drift with time.

- E. Disconnect the PV module DC wire connectors from the microinverter using the Enphase disconnect tool.
- F. If present, loosen and/or remove any bonding hardware.
- G. Remove the microinverter from the PV racking.





WARNING: Risk of electric shock. Risk of fire. Do not leave any connectors on the PV system disconnected for an extended period. If you do not plan to replace the microinverter immediately, you must cover any unused connector with a sealing cap.

Install a Replacement Microinverter

- A. When the replacement microinverter is available, verify that the AC branch circuit breaker is de-energized.
- B. Mount the microinverter bracket side up and under the PV module, away from rain and sun. Allow a minimum of 1.9cm (0.75") between the roof and the microinverter. Also allow 1.3cm (0.50") between the back of the PV module and the top of the microinverter



WARNING: Risk of equipment damage. Mount the microinverter under the PV module.

- Install the microinverter under the PV module to avoid direct exposure to rain, UV, and other harmful weather events.
 - Always install the microinverter bracket side up.
 - Do not mount the microinverter upside down.
 - Do not expose the AC or DC connectors (on the Enphase Q Cable connection, PV module, or the microinverter) to rain or condensation before the connectors are mated.
- C. Torque the mounting fasteners to the values shown. **Do not over torque.**
 - 6 mm (1/4") mounting hardware: 5 N m (45 to 50 in-lbs.)
 - 8 mm (5/16") mounting hardware: 9 N m (80 to 85 in-lbs.)
 - When using UL 2703 mounting hardware, use the manufacturer's recommended torque value
 - D. If you are using bonding hardware, the old bonding hardware should be discarded, and new bonding hardware must be used when installing the replacement microinverter.
 - E. Connect the microinverter to the Q Cable connector. Listen for a click as connectors engage.
 - F. Connect the DC leads of each PV module to the DC input connector of the microinverter.
 - G. Re-mount the PV module above the microinverter.
 - H. Energize the AC branch circuit breaker, and verify operation of the replacement microinverter by checking the Status LED on the connector side of the microinverter.
 - I. Use the Installer Toolkit mobile app to delete the old microinverter serial number from the Enphase IQ Envoy database. In Installer Toolkit, once connected to the Envoy:
 - a. Tap **Micros > Manage**.
 - b. Tap the checkbox  to the right of the microinverter serial number that you replaced.
 - c. Tap  to delete the microinverter from the IQ Envoy database.

- J. Add the new microinverter serial number to the Envoy database by initiating a device scan using one of the following methods:
- a. **Method 1: Initiate a scan using the Installer Toolkit mobile app**
 - In Installer Toolkit, once connected to the IQ Envoy, navigate to the Overview screen.
 - From the Overview screen, tap **Detected > Start Device Scan** to start a new 30-minute device scan.
 - If device scanning on the IQ Envoy is inhibited, the app displays **Scan Inhibited**. If you need to add more microinverters to the system when device scanning is inhibited on the IQ Envoy, you must use the Installer Toolkit scanning tool to provision them on the IQ Envoy, rather than using the IQ Envoy's device scanning function to discover them. If this is not possible and you need to enable device scanning on the IQ Envoy, contact Enphase Customer Support at enphase.com/en-us/support/contact.
 - b. **Method 2: Use an IQ Envoy**
 - Press the **Device Scan** button on the IQ Envoy. The IQ Envoy begins a 15-minute scan to identify all of the microinverters deployed at the site. The Microinverter Communications LED  flashes green during the scan.

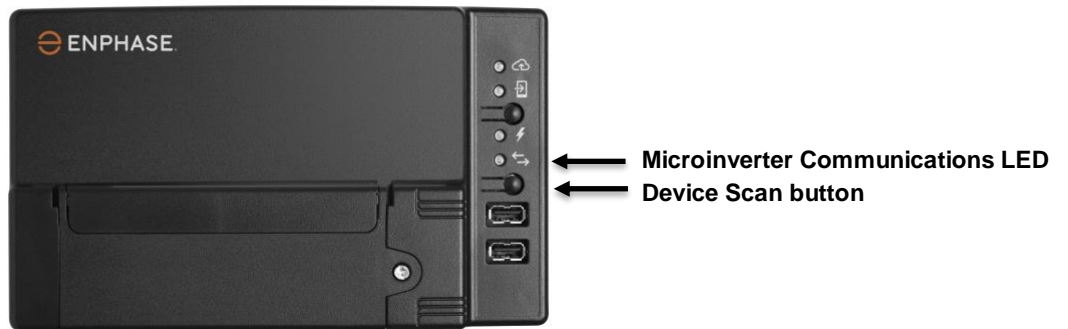

- K. Log in to Enlighten to use Enlighten's Array Builder to add the newly detected microinverter to the virtual array.
- L. Ship the old microinverter to Enphase using the supplied return-shipping label.

Ordering Replacement Parts

Replacement adaptors for the Microinverter include:

- **Q-DCC-2:** Cable Assembly, DC adaptor to MC-4
- **Q-DCC-5:** Cable Assembly, DC adaptor to Amphenol UTX

These parts are available from your Enphase distributor.

Enphase Q Cable Planning and Ordering

The Enphase Q Cable is a continuous length of 12 AWG, double insulated, outdoor-rated cable with integrated connectors for microinverters. These connectors are preinstalled along the Q Cable at intervals to accommodate varying PV module widths. The microinverters plug directly into the cable connectors.

The cabling is compatible with a variety of PV racking systems. For a list of approved PV racking systems, refer to the PV Racking Compatibility document on the Enphase website at enphase.com/support.

Connector Spacing Options

Q Cable is available in three connector spacing options. The gap between connectors on the cable can be 1.3 meters, 2.0 meters, or 2.3 meters. The 1.3 meter spacing is best suited for connecting PV modules installed in portrait orientation, while the 2.0 meter and 2.3 meter spacing allows you to install 60-cell and 72-cell PV modules in landscape orientation, respectively.

Cabling Options

Ordering options include:

Cable Model	Connector spacing	PV module orientation	Connector count per box
Q-12-10-240	1.3m (50")	Portrait	240
Q-12-17-240	2.0m (78")	Landscape (60-cell)	240
Q-12-20-200	2.3m (90")	Landscape (72-cell)	200

The Cabling System is flexible enough to adapt to almost any solar design. To determine the cable type, you need, apply the following considerations:

- When mixing PV modules in both portrait and landscape orientation, you may need to transition between cable types. See the preceding table for available cable types.
- To transition between cable types, install a Field Wireable connector pair.
- In situations where portrait modules are widely spaced, you may need to use landscape spaced cables for the portrait oriented PV modules and create loops of excess cable, if needed.



WARNING: Do not form loops smaller than 12 cm (4.75") in diameter.

Enphase Q Cable Accessories

The Enphase Q Cable is available with several accessory options for ease of installation, including:

- **Field wireable connectors (male):** (Q-CONN-10M) Make connections from any Field Wireable female connector
- **Field wireable connectors (female):** (Q-CONN-10F) Make connections from any Q Cable open connector or Field Wireable male connector
- **Cable clips:** (Q-CLIP-100) Used to fasten cabling to the racking or to secure looped cabling
- **Disconnect Tool:** (Q-DISC-10) Disconnect tool for Q Cable connectors, DC connectors, and AC module mount
- **Q Cable sealing caps (female):** (Q-SEAL-10) One needed to cover each unused connector on the cabling
- **Terminator:** (Q-TERM-10) Terminator cap for cut cable ends

Technical Data

Technical Considerations

Be sure to apply the following when installing the Enphase IQ 6 and/or IQ 6+ Micro System:



WARNING: Risk of equipment damage. You must match the DC operating voltage range of the PV module with the allowable input voltage range of the Enphase Microinverter.



WARNING: Risk of equipment damage. The maximum open circuit voltage of the PV module must not exceed the specified maximum input voltage of the Enphase Microinverter.

- PV modules must have conductors labeled "PV Wire" or "PV Cable" to comply with NEC for Ungrounded PV Power Systems.
- Verify that the voltage and current specifications of the PV module match those of the microinverter.
- The maximum short circuit current rating of the PV module must be equal to or less than the maximum input DC short circuit current rating of the microinverter.

The output voltage and current of the PV module depends on the quantity, size and temperature of the PV cells, as well as the insolation on each cell. The highest PV module output voltage occurs when the temperature of the cells is the lowest and the PV module is at open circuit (not operating).

Grid Interconnection Details

Both the Enphase IQ 6 and the IQ 6+ Microinverter are grid support interactive inverters. This type of inverter is also known as a Grid Support Utility Interactive Inverter (GSUII). The IQ 6 and IQ 6+ also comply with California Rule 21 - 2016 and Hawaii Rule 14H - 2017.

Grid Profiles

IQ 6 and IQ 6+ Microinverters have field-adjustable voltage and frequency trip points. Trip points are input voltage and frequency values that trigger the microinverters to shut down when the values are exceeded. If local regulations require adjustments to these trip points, or if the grid profile was not set up during registration, the installer can set up the system to use an alternate Grid Profile (set of trip points).



NOTE: Only an authorized installer, following the requirements of the local electrical utility, is allowed to make Grid Profile adjustments.



NOTE: Grid profile changes are applied only after a microinverter is detected.

In some regions and in some situations, microinverter trip points may be adjusted to account for high grid voltage or for local conditions.

Grid profile management tasks include:

- Set the grid profile for your region
- View or verify current trip point settings
- Generate a report for confirmation of site settings to the utility or other authority

To modify the grid profile or the parameters within the grid profile, installers must log in to their Enlighten account using their credentials.

The following tables show the parameter settings for the grid profiles available for North America:



NOTE: Simultaneous use of Fixed Power Factor and Volt/VAr is not supported.

Manufacturer's Stated Accuracy

Measurement	Default Tolerance of Measurement
Volts	+/- 1%
Amps	+/- 2%
Watts	+/- 5%
VAr	+/- 3%
Displacement power factor	+/- 2%
Hz	+/- 0.1 Hz
Time	The greater of +/- 2 cycles or 0.1% of total clearing time

Volt VAR Characteristics

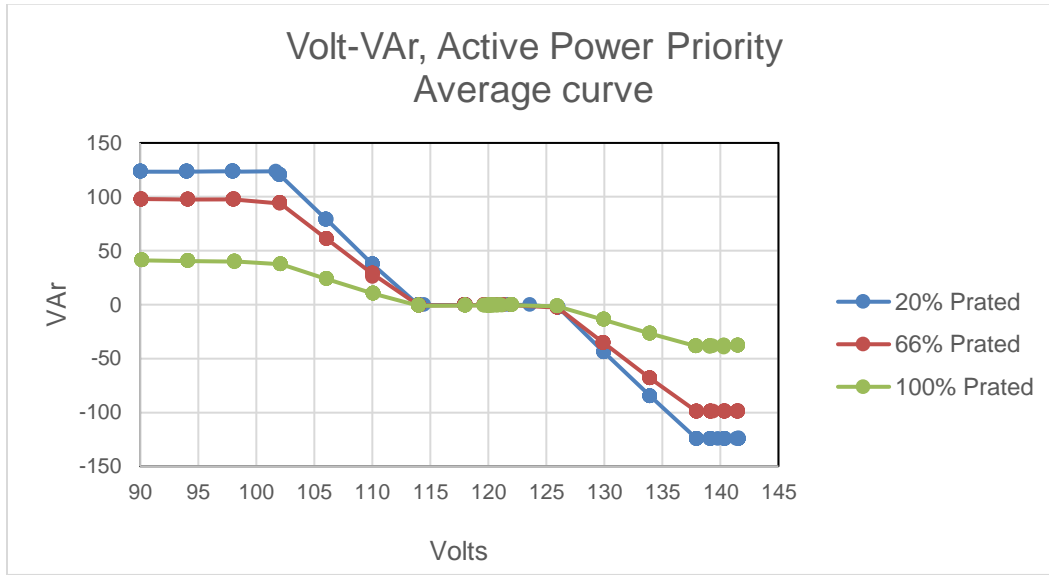

SA9: Low/High Voltage/Frequency Ride Through (L/HV/FRT) and Must Trip Settings

	Units	Ride Through		Must Trip	
		Max	Min	Max	Min
High voltage 3 - time	s	NA	NA	0.500	0.100
High voltage 3 - magnitude	percentage	NA	NA	121.7	106
High voltage 2 - time	s	19.800	0.300	20.000	0.500
High voltage 2 - magnitude	percentage	119	104	119	104
High voltage 1 - time	s	299.800	0.800	300.0	1.0
High voltage 1 - magnitude	percentage	115	102	115	102
Nominal operating range	percentage	110	88	110	88
Low voltage 1 - time	s	299.800	0.300	300.0	0.5
Low voltage 1 - magnitude	percentage	98	70	98	70
Low voltage 2 - time	s	149.800	0.000	150.0	0.2
Low voltage 2 - magnitude	percentage	96	50	96	50
Low voltage 3 - time	s	29.800	0.000	30.0	0.1
Low voltage 3 - magnitude	percentage	94	50	94	50

SA10: Low/High Frequency Ride Through (L/H FRT) and Must Trip Settings

	Units	Ride Through		Must Trip	
		Max	Min	Max	Min
High frequency 2-time	s	NA	NA	0.5	0.1
High frequency 2-magnitude	Hz	NA	NA	65	60.3
High frequency 1-time	s	599.8	0.8	600	0.16
High frequency 1-magnitude	Hz	65	60.1	65	60.1
Low frequency 1-time	s	599.8	0.8	600	0.16
Low frequency 1-magnitude	Hz	59.9	57	59.9	57
Low frequency 2-time	s	NA	NA	0.5	0.1
Low frequency 2-magnitude	Hz	NA	NA	59.9	50

SA11: Ramp Rate (RR) and Soft Start (SS)

	Units	Adjustment Range		Tolerance
		Max	Min	
Ramp-up rate	%I _{rated} /s	100	1	+/- 3% I _{rated}
Soft start ramp rate	%I _{rated} /s	100	0.11	+/- 3% I _{rated}

SA12: Specified Power Factor (SPF), aka (INV3)

	Units	Adjustment Range	
		Max	Min
Inductive, under excited, power factor	VAr/W	-0.7	-1.0
Capacitive, overexcited, power factor	VAr/W	1.0	0.7

SA13: Volt/VAr Mode (VV)

	Units	Adjustment Range	
		Max	Min
Minimum AC EPS voltage range	P.U.	0.80	1.0
Maximum EUT input voltage	P.U.	1.20	1.0
AC power	W	280	0
Reactive power absorption (inductive, under excited)	VAr	200	50
Reactive power production (capacitive, overexcited)	VAr	200	50
Slope	VAr/V	50	0
Deadband	V	48	4.8

SA14: Frequency-Watt (FW)

	Units	Adjustment Range	
		Max	Min
AC frequency with function enabled	Hz	57	65
High end frequency droop settings	Hz	62	60.1
Slope of frequency droop	%Prated/Hz	200	20

SA15: Volt-Watt (VW)

	Units	Adjustment Range	
		Max	Min
Adjustment range of the start of the curtailment function	V	130.0	121.0
Adjustment range of the stop of the curtailment function	V	138.0	123.0
Slope of voltage curtailment	%Prated/V	83	5.5

Specifications

See specifications in the following tables for:

- IQ6-60-2-US Microinverter
- IQ6PLUS-72-2-US Microinverter
- Enphase Q Cable

IQ6-60-2-US Microinverter Specifications

Enphase IQ6-60-2 Microinverter Parameters				
Topic	Unit	Min	Typical	Max
DC Parameters				
Commonly used module pairings ¹		195 W – 330 W		
Peak power tracking voltage	V	27		37
Operating voltage range	V	16		48
Maximum input DC voltage	V			48
Minimum / maximum start voltage	V	22		48
Maximum DC input short circuit current (module I _{sc})	A			15
Overvoltage class DC port			II	
DC Port backfeed under single fault	A			0
PV array configuration	1x1 ungrounded array; No additional DC side protection required; AC side protection requires max 20A per branch circuit			
AC Parameters				
Maximum continuous AC output power (-40°C to +65°C)	VA		230	
Peak output power	VA		240	
Power factor (adjustable)			0.7 leading 0.7 lagging	
Nominal AC output voltage range ²				
240 VAC (single phase)	V _{rms}	211		264
208 VAC (single phase)	V _{rms}	183		229
Nominal output current				
240 VAC (single phase)	A _{rms}		.96	
208 VAC (single phase)	A _{rms}		1.11	
Nominal frequency	Hz		60	
Extended frequency range	Hz	47		68
Maximum AC output over current protection device	A			20

¹ No enforced DC/AC ratio. See the compatibility calculator at enphase.com/en-us/support/module-compatibility

² Nominal Voltage Range can be extended if required by the utility.

Enphase IQ6-60-2 Microinverter Parameters				
Maximum AC output fault current & duration	mA rms for 6 cycles	850		
High AC voltage trip limit accuracy	mVrms			280
Low AC voltage trip limit accuracy	mVrms	179		
Frequency trip limit accuracy	%	±0.1		
Trip time accuracy	milliseconds	±33		
Overvoltage class AC port			III	
AC port backfeed under single fault	A		0	
Power factor at rated power			1.0	
Miscellaneous Parameters				
Maximum microinverters per 20 amp branch circuit 240 VAC (single phase) 208 VAC (single phase)	A			16 14
CEC weighted efficiency 240 VAC (single phase) 208 VAC (single phase)	%		97.0 96.5	
Static MPPT efficiency (weighted, ref EN 50530)	%		99.5	
Total harmonic distortion	%			5
Ambient temperature range	°C	-40		+65
Night tare loss	mW			50
Storage temperature range	°C	-40		+85
Features and Specifications				
Compatibility	Pairs with most 60-cell PV modules (the PV module DC conductors must be labeled "PV Wire" or "PV Cable" to be compliant with NEC for Ungrounded PV Power Systems)			
Dimensions not including mounting bracket	219 mm x 191 mm x 37.9mm (approximate)			
Connector type	MC-4 locking type			
Weight	1.5 kg (3.3 lbs.)			
Environmental category / UV exposure rating	Outdoor NEMA 250, type 6 (IP67)			
Torque specifications for fasteners (Do not over torque)	<ul style="list-style-type: none"> 6 mm (1/4") mounting hardware: 5 N m (45 to 50 in-lbs.) 8 mm (5/16") mounting hardware: 9 N m (80 to 85 in-lbs.) When using UL 2703 mounting hardware, use the manufacturer's recommended torque value 			
Cooling	Natural convection - no fans			
Relative humidity range	4% to 100% condensing			
Approved for wet locations	Yes			
Pollution degree	PD3			

Enphase IQ6-60-2 Microinverter Parameters	
Standard warranty term	enphase.com/warranty
Compliance	UL1741/IEEE1547, FCC Part 15 Class B, ICES-0003 Class B, CAN/CSA-C22.2 NO. 107.1-01 This product is UL Listed as PV Rapid Shut Down Equipment and conforms with NEC-2014 and NEC-2017 section 690.12 and C22.1-2015 Rule 64-218 Rapid Shutdown of PV Systems, for AC and DC conductors, when installed according manufacturer's instructions.
Grounding	The DC circuit meets the requirements for ungrounded PV arrays in NEC. Ground fault protection (GFP) is integrated into the class II double insulated microinverter.
Monitoring	Enlighten Manager and MyEnlighten monitoring options require an Enphase IQ Envoy
Communication	Power line
Integrated DC disconnect	The DC connector has been evaluated and approved for use as the load-break disconnect required by NEC 690.
Integrated AC disconnect	The AC connector has been evaluated and approved for use as the load-break disconnect required by NEC 690.

IQ6PLUS-72-2-US Microinverter Specifications

IQ6PLUS-72-2-US Microinverter Parameters				
Topic	Unit	Min	Typical	Max
DC Parameters				
Commonly used module pairings	W	235 W - 400+ W		
Peak power tracking voltage	V	27	36	45
Operating range	V	16		62
Maximum DC input voltage	V			62
Minimum / maximum start voltage	V	22		62
Maximum DC input short circuit current (module I _{sc})	A			15
Overvoltage class DC port			II	
DC Port backfeed under single fault	A			0
PV array configuration	1 x 1 ungrounded array; No additional DC side protection required; AC side protection requires max 20 A per branch circuit			
AC Parameters				
Maximum continuous AC output power (-40 to +65°C)	VA	280		
Peak output power	VA	290		
Power factor (adjustable)		0.7 leading 0.7 lagging		
Nominal AC output voltage range 240 VAC (single phase) 208 VAC (single phase)	V _{rms} V _{rms}	211 183	240	264 229
Nominal output current 240 VAC (single phase) 208 VAC (single phase)	A _{rms} A _{rms}		1.17 1.35	
Nominal frequency	Hz		60	
Extended frequency range	Hz	47		68
Maximum AC output over current protection device	A	20		
Maximum AC output fault current & duration	mA rms for 6 cycles	850		
High AC voltage trip limit accuracy	%	±1.0		
Low AC voltage trip limit accuracy	%	±1.0		
Frequency trip limit accuracy	%	±0.1		
Trip time accuracy	milliseconds	±33		
Overvoltage class AC port			III	
AC port backfeed under single fault	A		0	
Power factor at rated power			1.0	

IQ6PLUS-72-2-US Microinverter Parameters				
Miscellaneous Parameters				
Maximum microinverters per 20 amp (max) AC branch circuit				
240 VAC (single phase)				13
208 VAC (single phase)				11
CEC weighted efficiency	%			
240 VAC (single phase)		97.0		
208 VAC (single phase)		96.5		
Static MPPT efficiency (weighted, ref EN 50530)	%	99.5		
Total harmonic distortion	%			5
Ambient temperature range	°C	-40		+65
Night tare loss	mW			50
Storage temperature range	°C	-40		+85
Features and Specifications				
Compatibility	Pairs with most 60 and 72-cell PV modules			
Dimensions not including mounting bracket	219 mm x 191 mm x 37.9 mm (approximate)			
Connector type	MC-4 locking type			
Weight	1.5 kg (3 lbs.)			
Environmental category / UV exposure rating	Outdoor NEMA 250, type 6 (IP67)			
Torque specifications for fasteners (Do not over torque)	<ul style="list-style-type: none"> • 6 mm (1/4") mounting hardware: 5 N m (45 to 50 in-lbs.) • 8 mm (5/16") mounting hardware: 9 N m (80 to 85 in-lbs.) • When using UL 2703 mounting hardware, use the manufacturer's recommended torque value 			
Cooling	Natural convection - no fans			
Relative humidity range	4% to 100% condensing			
Approved for wet locations	Yes			
Pollution degree	PD3			
Communication	Power line			
Standard warranty term	enphase.com/warranty			
Compliance	UL62109, UL1741/IEEE1547, FCC Part 15 Class B, ICES-0003 Class B, CAN/CSA-C22.2 NO. 107.1-01 This product is UL Listed as PV Rapid Shut Down Equipment and conforms with NEC-2014 and NEC-2017 section 690.12 and C22.1-2015 Rule 64-218 Rapid Shutdown of PV Systems, for AC and DC conductors, when installed according manufacturer's instructions.			
Grounding	The DC circuit meets the requirements for ungrounded PV arrays in NEC. Ground fault protection (GFP) is integrated into the class II double insulated microinverter.			
Monitoring	Enlighten Manager and MyEnlighten monitoring options require an Enphase IQ Envoy			
Integrated DC disconnect	The DC connector has been evaluated and approved for use as the load-break disconnect required by NEC 690.			
Integrated AC disconnect	The AC connector has been evaluated and approved for use as the load-break disconnect required by NEC 690.			

Q Cable Specifications

Specification	Value
Voltage rating	600V
Voltage withstand test (kV/1min)	AC 3.0
Max DC conductor resistance (20°C) (Ω/km)	5.433
Insulation resistance (20°C)	≥20M (Ω/km)
System temperature range (ambient)	-40°C to +65°C (-40°F to 149°F)
Cable temperature rating	90°C Dry / 90°C Wet
Cable rating	DG
Certification	UL 3003, TC-ER equivalent
Flame test rating	FT4
Cable conductor insulator rating	THHN/THWN-2
Environmental protection rating	IEC 60529 IP67 NEMA 6
UV resistance	720h
Compliance	RoHS, OIL RES I, CE, UV Resistant, combined UL for Canada and United States
Conductor size	12 AWG
Maximum loop size	12 cm (4.75 ")
Flat cable dimensions	6 mm x 9.5 mm (0.2" x 0.37")
Sealing cap dimensions	38.6 mm x 20 mm (1.5" x 0.7")
Cable connector dimensions	20 mm x 1.1 mm x 6.5 mm (0.7" x 0.04" x 0.25")

Enphase Connector Ratings

Enphase connectors in the following table have a maximum current of 20A, a maximum OCPD of 20 A, and an ambient temperature range of -40° to +79° C (-40° to +174.2° F).

Part Number	Model	Maximum Voltage
840-00387	Q-12-10-240	250 VAC
840-00388	Q-12-17-240	250 VAC
840-00389	Q-12-20-200	250 VAC
840-00800	Q-DCC-7	300 VDC
840-00385	Q-DCC-2	100 VDC
840-00386	Q-DCC-5	100 VDC

Enphase Installation Map

To Sheet / A la hoja de: ↑

Panel Group/Grupo de los paneles: Azimuth/Azimit: Tilt/Inclinación: Sheet/Hoja _____ of/de _____		Customer/Cliente:					Installer/Instalador:		N S E W N S E O
1	2	3	4	5	6	7			↑
A									
B									
C									
D									
E									
F									
G									
H									
J									
K									
L									
M									

To Sheet / A la hoja de: ↓

Scan completed map and upload it to Enphase. Click "Add a New System" at <https://enlighten.enphaseenergy.com>. Use this map to build the virtual array in Enlighten's Array Builder. /

Escanee el mapa completo y cárguelo en Enphase. Haga clic en "Añadir nuevo sistema" en <https://enlighten.enphaseenergy.com>. Utilice este mapa para crear el conjunto de paneles virtual en el Creador de conjuntos de paneles de Enlighten.

Envoy Serial Number Label /
Número de serie de Envoy



To Sheet / A la hoja de: ↓

Sample Wiring Diagram:

